

Sistema rapido per il cambio dei fili  
 Quick and tool-free wire replacement system  
 Schnelles und werkzeugloses Drahtwechselsystem  
 Sistema cambio de hilo rápido  
 Système rapide de remplacement du fil

MOD		
mod.	cod.	kg
<b>DMI / TFZ</b>	1002882	280
<b>DMI / TMU</b>	1002884	280
<b>DMI / LFG</b>	1002886	280
<b>DMI / TFB</b>	1002887	280
<b>DMI / TFA</b>	1002888	280
<b>DMI / TRE</b>	1003005	280

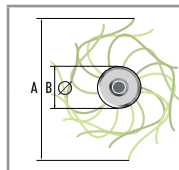

Ø A  
**450 mm**

Ø B  
**130 mm**

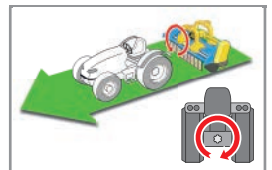
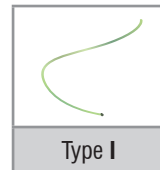

Di serie	Standard equipment	Serienmässig	Estándar	De série
<ul style="list-style-type: none"> <li>Seratoio da 40 litri indipendente</li> <li>Doppio sistema filtrante</li> <li>Kit attacco pompa</li> <li>Raccorderia oleodinamica con attacchi a sgancio rapido per una veloce rimozione della macchina</li> <li>Kit scambiatore di calore</li> <li>Posizioni di lavoro gestite direttamente dalla trattrice tramite Joystick multifunzione removibile</li> <li>Regolazione giri motore</li> <li>Blocco distribuzione gestito elettronicamente</li> <li>Accensione-spegnimento</li> <li>1 set di fili pre-installato</li> <li>Sistema rapido per il cambio dei fili</li> <li>Protezioni antinfortunistiche a normative CE</li> </ul>	<ul style="list-style-type: none"> <li>Independent 40 liters tank</li> <li>Double filtering system</li> <li>Pump connection kit</li> <li>Hydraulic fittings with quick release connections for a quick removal of the machine</li> <li>Heat exchanger kit</li> <li>Working positions managed directly by the tractor using a removable multifunction joystick</li> <li>Engine revolutions adjustment</li> <li>Electronically managed distribution block</li> <li>On-off switching</li> <li>1 set of pre-installed wires</li> <li>Quick and tool-free wire replacement system</li> <li>Protective equipment as per EC safety rules</li> </ul>	<ul style="list-style-type: none"> <li>Unabhängiger 40Lt Tank</li> <li>Doppeltes Filtersystem</li> <li>Pumpenverbindingssatz</li> <li>Hydraulische Armaturen mit Schnellkupplungen für eine schnelle Demontage der Maschine</li> <li>Wärmetauscher-Kit</li> <li>Direkte Steuerung der Arbeitspositionen durch den Traktor mit einem abnehmbaren Multifunktions-Joystick</li> <li>Einstellung der Motordrehzahl</li> <li>Elektronisch gesteuerter Verteilerblock</li> <li>Ein-Aus-Schaltung</li> <li>1 Satz vorinstallierter Drähte</li> <li>Schnelles und werkzeugloses Drahtwechselsystem</li> <li>Unfallschutz nach EU-Vorschriften</li> </ul>	<ul style="list-style-type: none"> <li>Tanque de 40 litros independiente</li> <li>Doble sistema de filtrado</li> <li>Kit de conexión de bomba</li> <li>Accesorios hidráulicos con conexiones de liberación rápida para una rápida extracción de la máquina</li> <li>Kit de intercambiador de calor</li> <li>Posiciones de trabajo gestionadas directamente por el tractor mediante un joystick</li> <li>Ajuste de revoluciones del motor</li> <li>Bloque de distribución gestionado electrónicamente</li> <li>Encendido-apagado</li> <li>1 juego de cables preinstalados</li> <li>Sistema cambio de hilo rápido</li> <li>Protecciones de seguridad de acuerdo con la norma CE</li> </ul>	<ul style="list-style-type: none"> <li>Réservoir indépendant 40 litres</li> <li>Système de double filtration</li> <li>Kit de connexion de pompe</li> <li>Raccords hydrauliques avec raccords rapides pour un retrait rapide de la machine</li> <li>Kit échangeur de chaleur</li> <li>Positions de travail gérées directement par le tracteur à l'aide d'un joystick multifonction amovible</li> <li>Réglage de la rotation du moteur</li> <li>Bloc de distribution géré électroniquement</li> <li>Commutation marche-arrêt</li> <li>1 jeu de fils pré-installés</li> <li>Système rapide de remplacement du fil</li> <li>Protections contre les accidents aux normes CE</li> </ul>

cod.	Ricambi	Spare parts	Ersatzteile	Recambios	Pièces de rechange
5450043	Bobina filo 630 mt Ø 4 mm	Wire 630 mt Ø 4 mm	Garnrolle 630 mt Ø 4 mm	Hilo 630 mt Ø 4 mm	Bobine de fil 630 mt Ø 4 mm

DMI	INTER-ROW WEEDER FOR FLAIL MOWER
DMI	MECHANISCHE UNKRAUTMÄHBÜRSTE FÜR MULCHER
DMI	DESBROZADORA INTERFILA MECÁNICA
DMI	MACHINE Á ÉBOURGEONNER AVEC PALPEUR MÉCANIQUE



ORIGINAL MADE IN ITALY | zanon.it

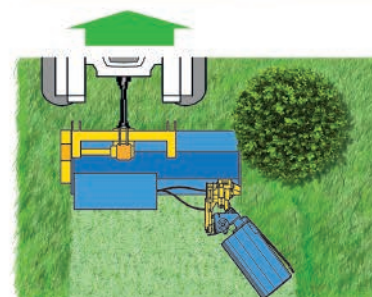
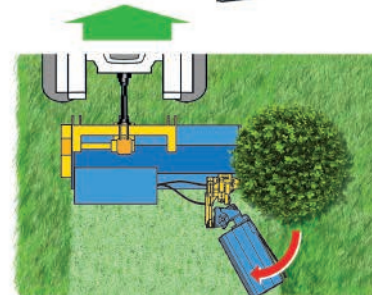
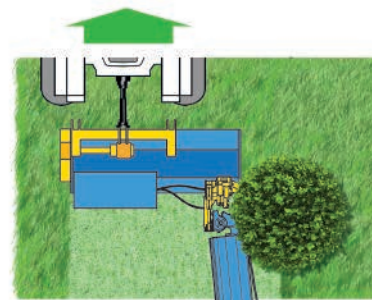
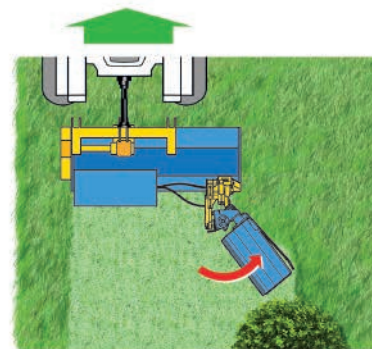
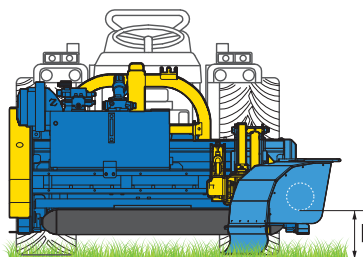
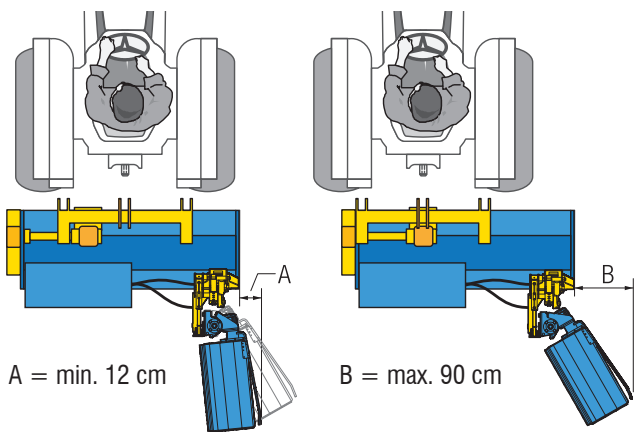

### MOVIMENTO 1 / MOVEMENT 1

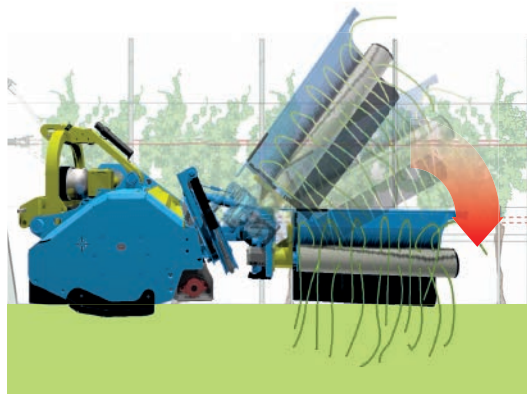

Apertura e chiusura braccio diserbatrice meccanica  
 Arm opening and closing  
 Antishock System: Anfahrtsicherung  
 Apertura y cierre del brazo mecánico  
 Ouverture et fermeture du bras

### MOVIMENTO 2 / MOVEMENT 2

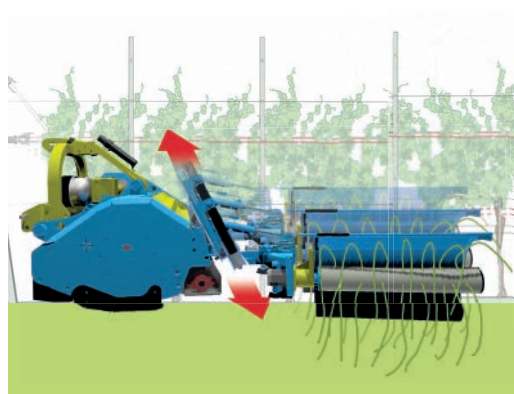

Regolazione altezza asse rullo  
 Arm's height adjustment  
 Einstellung Arbeitsposition  
 Regulación de altura del rodillo  
 Réglage hauteur axe du rouleau



Sistema antishock regolabile per l'attenuazione dell'urto  
 Adjustable anti-shock system for shock absorption  
 Einstellbares Anfahrtsicherung-System zur Stoßdämpfung  
 Sistema anti impacto regulable para amortiguar golpe  
 Système antichoc réglable pour atténuer l'impact



Rientro testata con sistema a molla  
 Movement with spring system  
 Schwenkung mit Federsystem  
 Cierre y apertura del cabezal con sistema de muelle  
 Retour de tête avec système de ressort



Regolazione giri rotore  
 Rotor speed control  
 Einstellung Rotorgeschwindigkeit  
 Regulación vueltas rotor  
 Réglage de la vitesse du rotor

