

VERSIONE SINGOLA

SINGLE VERSION

EINZELVERSION

VERSIÓN INDIVIDUAL

VERSION SIMPLE

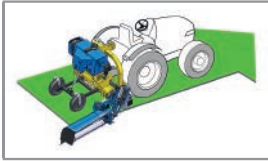
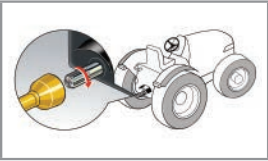

JOYSTICK MULTIFUNZIONE

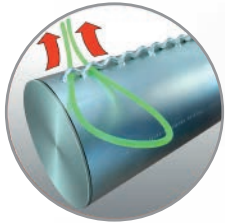
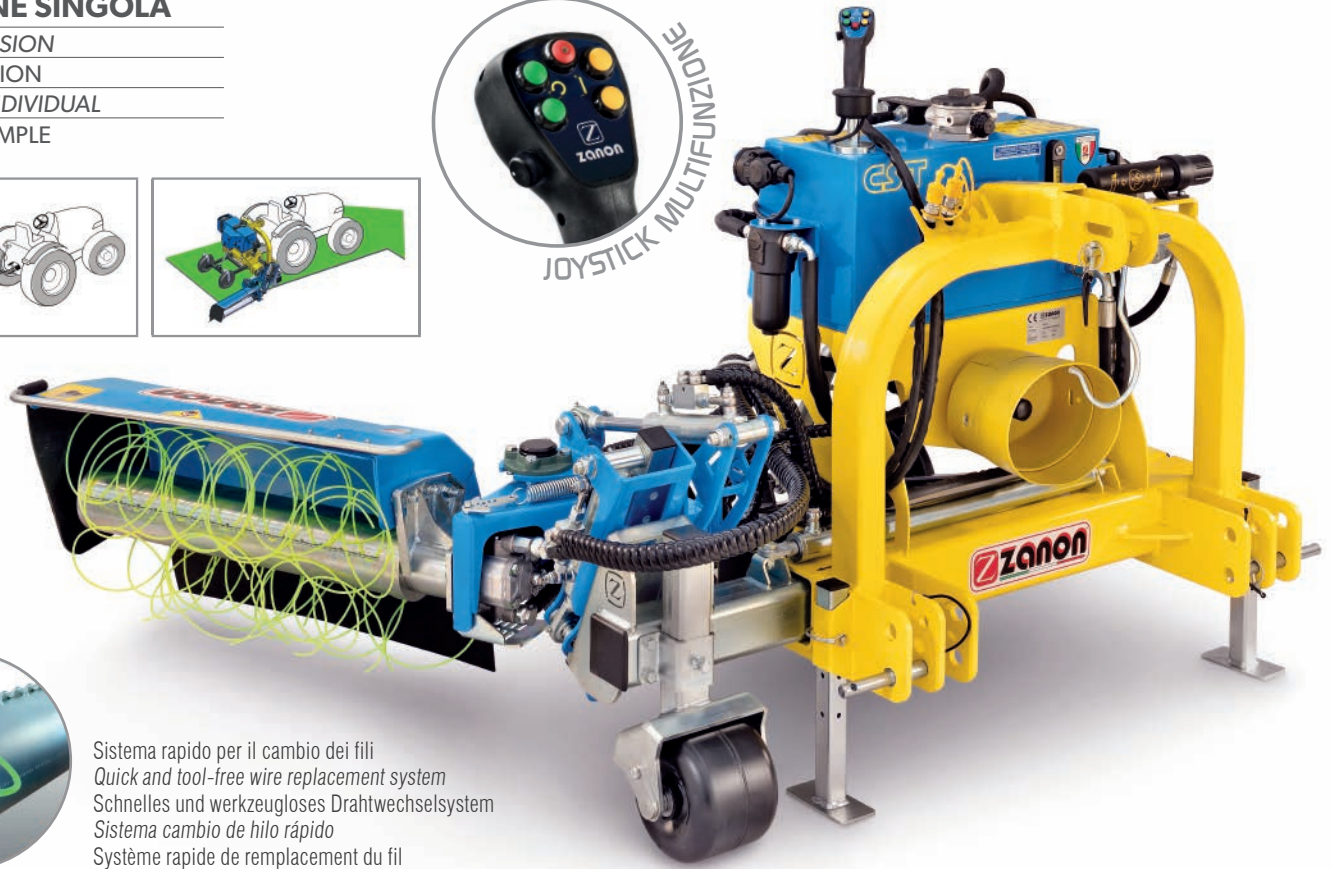

Sistema rapido per il cambio dei fili
Quick and tool-free wire replacement system
Schnelles und werkzeugloses Drahtwechselsystem
Sistema cambio de hilo rápido
Système rapide de remplacement du fil

MOD							
mod.	cod.	HP	rpm/min	type	cm	cm	kg
CST+DMI singola	1002954	40 - 100	540	T-50 / T-60	75	165×175×110	460
CST+DMI singola compatta	1003032	40 - 100	540	T-50 / T-60	75	135×175×110	400

Di serie	Standard equipment	Serienmässig	Estándar	De série
<ul style="list-style-type: none"> • Attacco a 3 punti Cat. I-II • Impianto oleodinamico completo di serbatoio, sistema filtrante e scambiatore di calore • Joystick multifunzione • Spostamento laterale idraulico apertura/chiusura • Regolazioni posizione rotore regolabili idraulicamente • Regolazione dei giri direttamente dal trattore • Sistema rapido per il cambio dei fili • Sistema antishock regolabile per l'attenuazione dell'urto • Ruote di appoggio con cresta regolabili in altezza • Protezioni antinfortunistiche a normative CE 	<ul style="list-style-type: none"> • 3-point linkage cat. I-II • Hydraulic system complete with tank, filter system and heat exchanger • Multifunction Joystick • Hydraulic side shift opening/closing • Hydraulically adjustable rotor positions • RPM adjustment directly from the tractor • Quick and tool-free wire replacement system • Adjustable anti-shock system for shock absorption • Height-adjustable crest wheels • Protective equipment as per EC safety rules 	<ul style="list-style-type: none"> • 3-Punkt-Anbau Kat. I-II • Hydraulisches System komplett mit Tank, Filtersystem und Wärmetauscher • Multifunktions-Joystick • Hydraulische Seitenverschiebung öffnen/schließen • Hydraulisch einstellbare Rotorpositionen • Drehzahleinstellung direkt vom Traktor aus • Schnelles und werkzeugloses Drahtwechselsystem • Einstellbares Anfahrsicherungssystem zur Stoßdämpfung • Höhenverstellbare Räder mit Führung • Unfallschutz nach EU-Vorschriften 	<ul style="list-style-type: none"> • Enganche a 3 punto Cat. I-II • Kit de centralita hidráulica completa de depósito, sistema filtrante e intercambiador de calor • Joystick multifunción • Desplazador lateral hidráulico apertura/cierre • Regulación posterior rotor regulable hidráulicamente • Regulación del número de vueltas desde el tractor • Sistema cambio de hilo rápido • Sistema anti impacto, regulable para amortiguar golpe • Rueda de apoyo con regulación en altura • Protecciones de seguridad de acuerdo con la norma CE 	<ul style="list-style-type: none"> • Attelage 3 points Cat. I-II • Système hydraulique complet avec réservoir, système de filtrage et échangeur de chaleur • Joystick multifonction • Déplacement latéral hydraulique ouverture/fermeture • Réglage hydraulique position du rotor • Réglage de la vitesse géré directement de le tracteur • Système rapide de remplacement du fil • Système antichoc réglable pour atténuer l'impact • Roues de support avec guide réglables en hauteur • Protections contre les accidents aux normes CE

cod.	A richiesta	On request	Auf Anfrage	Opcionales	Sur demande
5130005	Cardano T-50	PTO shaft T-50	Gelenkwelle T-50	Cardán T-50	Cardan T-50
5130009	Cardano T-60	PTO shaft T-60	Gelenkwelle T-60	Cardán T-60	Cardan T-60
5411041	Ruota in ferro senza cresta	Smooth iron wheel	Glatte Eisenräder	Rueda de hierro lisa	Roue en fer lisse

CST+DMI SINGOLA
CST+DMI SINGOLA
CST+DMI SINGOLA
CST+DMI SINGOLA

INDIPENDENT CASTLE with INTER-ROW MECHANICAL WEEDER
MECHANISCHE UNKRAUTMÄHBÜRSTE
DESBROZADORA INTERLÍNEAS MECÁNICA
MACHINE À ÉBOURGEONNER AVEC PALPEUR MÉCANIQUE



ORIGINAL MADE IN ITALY | zanon.it

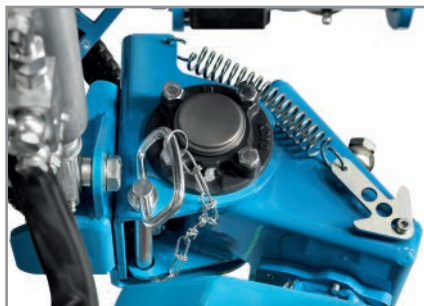
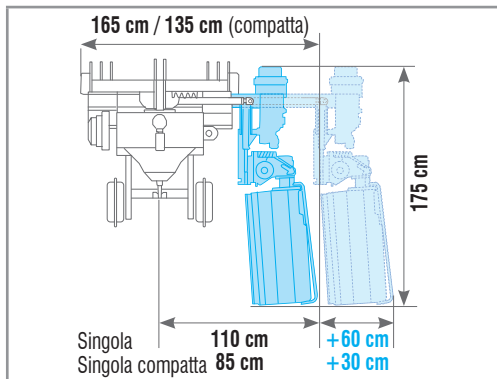
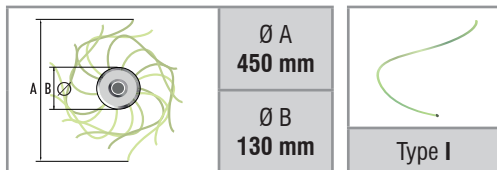

Sistema antishock regolabile per l'attenuazione dell'urto
 Adjustable anti-shock system for shock absorption
 Einstellbares Anfahrtsicherung-System zur Stoßdämpfung
 Sistema anti impacto regulable para amortiguar golpe
 Système antichoc réglable pour atténuer l'impact

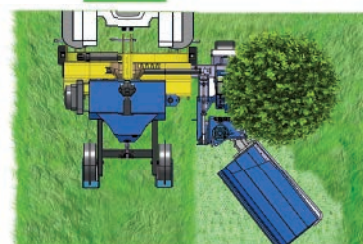
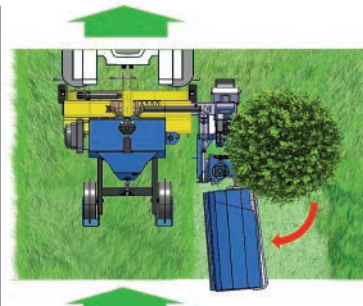

CST+DMI SINGOLA

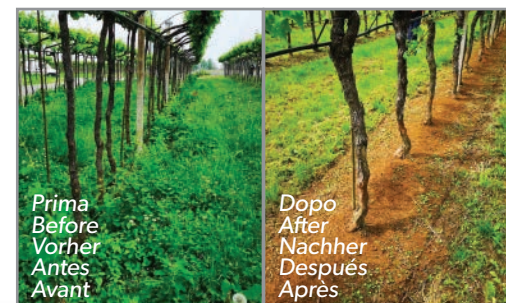

Scambiatore di calore
 Heat exchanger
 Wärmetauscher
 Intercambiador de calor
 Échangeur de chaleur



Regolazione giri rotore
 Rotor speed control
 Einstellung Rotorgeschwindigkeit
 Regulación vueltas rotor
 Réglage de la vitesse du rotor

Joystick multifunzione con base magnetica
 Multifunction Joystick with magnetic base
 Multifunktions-Joystick bedienung mit magnet
 Joystick multifunción con base magnética
 Joystick multifonction avec base magnétique



cod.	Ricambi	Spare parts	Ersatzteile	Recambios	Pièces de rechange
5450043	Bobina filo 630 mt Ø 4 mm	Wire 630 mt Ø 4 mm	Garnrolle 630 mt Ø 4 mm	Hilo 630 mt Ø 4 mm	Bobine de fil 630 mt Ø 4 mm