

CTV	CULTIVATOR AND TOOL CARRIER
CTV	GRUBBER UND GERÄTETRÄGER
CTV	CULTIVADOR Y PORTAHERRAMIENTAS
CTV	CULTIVATEUR ET PORTE-OUTILS



ORIGINAL MADE IN ITALY | zanon.it

## VERSIONE PRO

PRO VERSION  
 PROFIVERSION  
 VERSIÓN PRO  
 VERSION PRO



JOYSTICK MULTIFUNZIONE

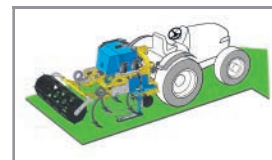
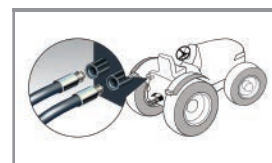

CTV PRO

# CTV PRO

L'immagine della macchina è indicativa. Gli utensili e gli accessori sono a richiesta. – The picture of the machine is indicative. Tools and accessories are on request.

MOD						
mod.	cod.	HP	nr	cm	cm	kg
CTV 140 PRO	1003096	40 - 60	3 *	15	160×195×130	600
CTV 160 PRO	1003097	70 - 90	5 *	15	180×195×130	650
CTV 180 PRO	1003098	70 - 90	5 *	15	200×195×130	700
CTV 200 PRO	1003107	70 - 90	7 *	15	220×195×130	800
CTV 220 PRO	1003108	70 - 90	7 *	15	240×195×130	825
CTV 240 PRO	1003109	70 - 90	7 *	15	260×195×130	850

\*+2 ancore a molla con vomerini da 26 cm a richiesta \*+2 spring-loaded anchors with 26 cm ploughshares on request \*+2 Federbelastete Zinken mit 26 cm Pflugscharen auf Anfrage  
 \*+2 punta a muelle con reja de 26 cm bajo pedido \*+2 ancras à ressort avec socs de 26 cm sur demande

Di serie	Standard equipment	Serienmässig	Estándar	De série
<ul style="list-style-type: none"> <li>• Attacco a 3 punti Cat. II</li> <li>• Impianto oleodinamico completo di serbatoio, sistema filtrante e scambiatore di calore</li> <li>• Impianto idraulico alimentato dal trattore</li> <li>• Joystick multifunzione</li> <li>• Spostamento laterale idraulico apertura/chiusura</li> <li>• 2 bracci portattrezzi completi di doppio tastatore</li> <li>• Regolazione meccanica altezza di lavoro bracci laterali indipendente dalle ancore a molla</li> <li>• Ancore a molla con vomerini da 26 cm</li> <li>• Rullo posteriore dentato o a gabbia (da specificare in fase d'ordine) regolabile in altezza</li> <li>• Protezioni antinfortunistiche a normative CE</li> </ul>	<ul style="list-style-type: none"> <li>• 3-point linkage cat. II</li> <li>• Hydraulic system complete with tank, filter system and heat exchanger</li> <li>• Tractor-powered hydraulics</li> <li>• Multifunction Joystick</li> <li>• Hydraulic side shift opening/closing</li> <li>• 2 tool-holding arms complete with double sensor</li> <li>• Mechanical adjustment of working height of side arms independent of spring anchors</li> <li>• Spring-loaded anchors with 26 cm ploughshares</li> <li>• Rear toothed or cage roller (to be specified when ordering) adjustable in height</li> <li>• Protective equipment as per EC safety rules</li> </ul>	<ul style="list-style-type: none"> <li>• 3-Punkt-Anbau Kat. II</li> <li>• Hydraulisches System komplett mit Tank, Filtersystem und Wärmetauscher</li> <li>• Traktorbetriebenes Hydrauliksystem</li> <li>• Multifunktions-Joystick</li> <li>• Hydraulische Seitenverschiebung öffnen/schließen</li> <li>• 2 Geräteträger-Arme komplett mit Doppeltaster</li> <li>• Mechanische Einstellung der Arbeitshöhe der Seitenarme unabhängig von den Federankern</li> <li>• Federbelastete Zinken mit 26 cm Pflugscharen</li> <li>• Höhenverstellbare Gezähnte- oder Stabwalze (bei Bestellung anzugeben)</li> <li>• Unfallschutz nach EU-Vorschriften</li> </ul>	<ul style="list-style-type: none"> <li>• Enganche a 3 punto Cat. II</li> <li>• Kit de centralita hidráulica completa de depósito, sistema filtrante e intercambiador de calor</li> <li>• Sistema hidráulico alimentado por el tractor</li> <li>• Joystick multifunción</li> <li>• Desplazador lateral hidráulico apertura/cierre</li> <li>• 2 brazos porta herramienta completos de doble palpador</li> <li>• Regulación mecánica de la altura de trabajo, brazos laterales independientes a muelle</li> <li>• Punta a muelle con reja de 26 cm</li> <li>• Rodillo posterior dentado o a barras (especificar al ordenar) regulable en altura</li> <li>• Protecciones de seguridad de acuerdo con la norma CE</li> </ul>	<ul style="list-style-type: none"> <li>• Attelage 3 points Cat. II</li> <li>• Système hydraulique complet avec réservoir, système de filtrage et échangeur de chaleur</li> <li>• Système hydraulique alimenté par le tracteur</li> <li>• Joystick multifonction</li> <li>• Déplacement latéral hydraulique ouverture/fermeture</li> <li>• 2 bras porte-outils avec double palpeur</li> <li>• Réglage mécanique de la hauteur de travail des bras latéraux indépendant des ancras à ressort</li> <li>• Ancres à ressort avec socs de 26 cm</li> <li>• Rouleau arrière denté ou avec barres (à préciser lors de la commande) réglable en hauteur</li> <li>• Protections contre les accidents aux normes CE</li> </ul>

## UTENSILI

WORKING TOOLS

WERKZEUGE

HERRAMIENTAS DE TRABAJO

OUTILS DE TRAVAIL

CTV

CTV PRO

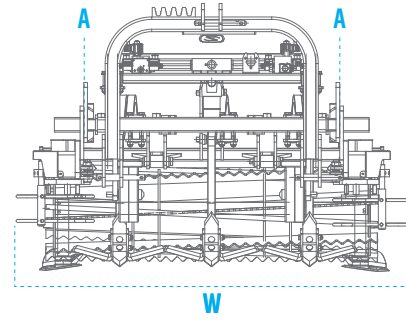
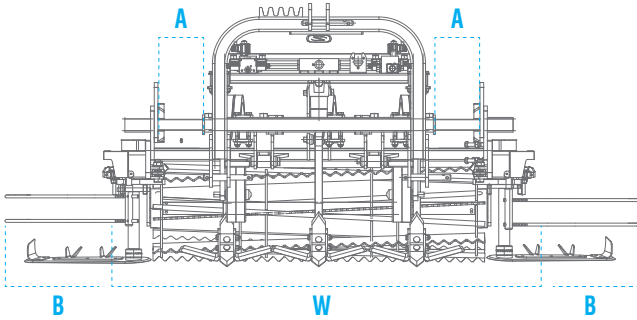

MOD	Macchina con braccetti e utensili aperti Machine with open arms and tools				
mod.	B	A	W	A	B
CTV 140	35	15	160	15	35
CTV 160	35	15	180	15	35
CTV 180	35	15	200	15	35
CTV 200	35	15	220	15	35
CTV 220	35	15	240	15	35
CTV 240	35	15	260	15	35

MOD	Macchina con braccetti e utensili chiusi Machine with closed arms and tools				
mod.	B	A	W	A	B
CTV 140	--	--	160	--	--
CTV 160	--	--	180	--	--
CTV 180	--	--	200	--	--
CTV 200	--	--	220	--	--
CTV 220	--	--	240	--	--
CTV 240	--	--	260	--	--

### DSL 2

**Kit dischi scalzatori (2 dischi)**  
2 dischi in parallelo con spatola pulisci ceppo. Profondità di lavoro 30 cm

**Kit hydraulic discs (2 discs)**  
2 discs can be fitted in parallel with row cleaner blade. Working depth 30 cm

**Kit angetrieben Scheiben (2)**  
2 Scheiben können parallel mit Reihenreiwigungsmesser montiert werden. Arbeitstiefe 30 cm

**Kit grada de discos (2 discos)**  
Posibilidad de montar 2 discos paralelos, con espátula limpia cepas. Profundidad de trabajo 30 cm

**Kit disques dechauseuse (2)**  
Possibilité de monter 2 disques en parallèle, avec spatule de nettoyage des cepes. Profondeur de travail 30 cm

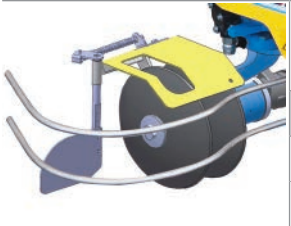

cod.	cm	cm	l/min	kg
2050868 DX	W	W : W	30	35
2050869 SX	W + 50	W + 50 : W + 50	30	35

### DSL 3

**Kit dischi scalzatori (3 dischi)**  
3 dischi in parallelo con spatola pulisci ceppo. Profondità di lavoro 30 cm

**Kit hydraulic discs (3 discs)**  
3 discs can be fitted in parallel with row cleaner blade. Working depth 30 cm

**Kit angetrieben Scheiben (3)**  
3 Scheiben können parallel mit Reihenreiwigungsmesser montiert werden. Arbeitstiefe 30 cm

**Kit grada de discos (3 discos)**  
Posibilidad de montar 3 discos paralelos, con espátula limpia cepas. Profundidad de trabajo 30 cm

**Kit disques dechauseuse (3)**  
Possibilité de monter 3 disques en parallèle, avec spatule de nettoyage des cepes. Profondeur de travail 30 cm

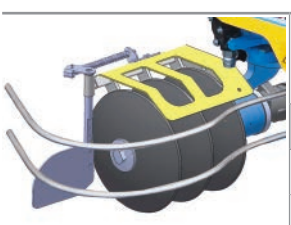

cod.	cm	cm	l/min	kg
2050694 DX	W	W : W	30	50
2050695 SX	W + 50	W + 50 : W + 50	30	50

CTV CTV PRO	CULTIVATOR AND TOOL CARRIER
CTV CTV PRO	GRUBBER UND GERÄTETRÄGER
CTV CTV PRO	CULTIVADOR Y PORTAHERRAMIENTAS
CTV CTV PRO	CULTIVATEUR ET PORTE-OUTILS



ORIGINAL MADE IN ITALY | zanon.it

# UTENSILI

WORKING TOOLS

WERKZEUGE

HERRAMIENTAS DE TRABAJO

OUTILS DE TRAVAIL

CTV

CTV PRO

CTV UTENSILI

## LSI

Kit lama scalzatrice con ala laterale ed esplosori	Kit blade weeder and side deflectors for Weeder blade	Kit Stockräumer und exploder für egge mit räumschar	Kit cuchilla interfilar y aletas para cuchilla binadora	Kit lame et sous-soleuses pour lame sarclouse
	cod.	cm	cm	l/min
	2050681 DX	W	W : W	--
	2050682 SX	W + 50	W + 50 : W + 50	--
		kg		
		10		
		10		

## ASI

Kit aratro scalzatore con spatola pulisci ceppo. Profondità di lavoro max 15 cm	Kit plough with row cleaner blade. Working depth max. 15 cm	Kit Pflug mit Säuberungschar. Max. Arbeitstiefe 15 cm	Kit arado desporcador con espátula limpia cepas. Profundidad de trabajo máx. 15 cm	Kit charrue avec spatule de nettoyage des ceps. Profondeur de travail max 15 cm
	cod.	cm	cm	l/min
	2050683 DX	W	W : W	--
	2050684 SX	W + 50	W + 50 : W + 50	--
		kg		
		18		
		18		

## RFI

Kit rotofresa idraulico 3 denti fresa Ø di lavoro 35 cm Paraterra regolabile	Kit hydraulic rotary tiller 3-Teeth tiller Working Ø 35 cm Soil & stone deflector adjustable	Kit Zinkenkreisel 3 Zähne Fräse Ø Arbeit 35 cm Erd- & Steinschieber verstellbar	Kit roto fresa hidraulica 3 dientes fresa Ø de trabajo 35 cm Cuchilla para-tierra ajustable	Kit roto-fraise hydraulique 3 dents fraise Ø de travail 35 cm Lame convoyeur de terre réglable
	cod.	cm	cm	l/min
	2050688 DX	W	W : W	30
	2050689 SX	W + 50	W + 50 : W + 50	30
		kg		
		45		
		45		

## Kit inclinazione bracci portatezzi

Kit inclinazione bracci portatezzi Nota: sono necessari 4 innesti rapidi sulla trattoria Larghezza macchina + 8 cm	Tilting kit for tool carrier arms Note: 4 quick-release couplings are required on the tractor Width machine + 8 cm	Kit Neigung für werkzeugeträgerarme Vermerken: Schnellkupplungen Werder am Traktor benötigt Maschinenbreite + 8 cm	Kit inclinacion brazo porta herramienta Nota: se requieren 4 acoplamientos rápidos en el tractor Ancho de la máquina + 8 cm	Kit inclinaison bras avec porte outils Remarque: 4 raccords rapides sont nécessaires sur le tracteur Largeur de la machine + 8 cm
	cod.	cm	cm	l/min
	2050833	W	W : W	10
		W + 50	W + 50 : W + 50	
		kg		
		25		

## UTENSILI

WORKING TOOLS

WERKZEUGE

HERRAMIENTAS DE TRABAJO

OUTILS DE TRAVAIL

CTV

CTV PRO

Kit ancora aprisolco	Kit anchor fixed	Kit Zinken Fest	Kit punta abre surco	Kit ancre
	cod.	cm	cm	l/min
	2050687	90 150	90 : 90 150 : 150	--
				kg
				8

Kit disco aprisolco	Kit disc fixed	Kit Scheibenflug fest	Disco de corte	Kit disque
	cod.	cm	cm	l/min
	2050690 DX	90	90 : 90	--
	2050691 SX	150	150 : 150	--
				kg
				8

Ancore a molla con vomerini da 26 cm	Spring-loaded anchors with 26 cm ploughshares	Federbelastete Zinken mit 26 cm Pflugscharen	Punta a muelle con reja de 26 cm	Ancre à ressort avec socs de 26 cm
	cod.	cm	cm	l/min
	2050773 DX	25	15	--
	2050774 SX	25	15	--
				kg
				17

Ancora a molla Dente a "scarpetta" e aletta laterale	Spring-loaded anchor Plowshare shoes and side flap	Federbelastete Zinken Pflugschardschuhe und Seitenklappe	Punta a muelle Kit desporcador con alas laterales	Ancre à ressort Kit ancre avec ailes latérales
	cod.	cm	cm	l/min
	2050771 DX	39	22	--
	2050772 SX	39	22	--
				kg
				22

CTV CTV PRO	CULTIVATOR AND TOOL CARRIER
CTV CTV PRO	GRUBBER UND GERÄTETRÄGER
CTV CTV PRO	CULTIVADOR Y PORTAHERRAMIENTAS
CTV CTV PRO	CULTIVATEUR ET PORTE-OUTILS

# UTENSILI

WORKING TOOLS

WERKZEUGE

HERRAMIENTAS DE TRABAJO





OUTILS DE TRAVAIL

CTV



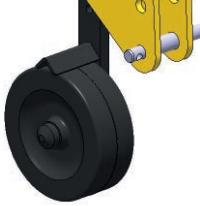

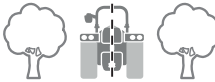
CTV PRO

CTV UTENSILI





Ruote di profondità regolabili in altezza | Height-adjustable depth wheels | Tiefenräder mit Führung | Ruedas de profundidad con regulación en altura | Roues de profondeur avec guide réglables en hauteur

					
cod.	cm	cm	l/min	kg	
2050780	--	--	--	6	

Rullo a gabbia | Cage roller | Stabwalze | Rodillo de jaula | Rouleau barre

	MOD			
	mod.	cod.	cm	kg
	CTV 140 *	3232543	41,5	52
	CTV 160 *	3232529	41,5	55
	CTV 180 *	3232544	41,5	63
	CTV 200 *	3232654	41,5	68
	CTV 220 *	3232655	41,5	72
	CTV 240 *	3232656	41,5	80

Rullo dentato | Toothed roller | Zahnwalze | Rodillo dentado | Rouleau denté

	MOD			
	mod.	cod.	cm	kg
	CTV 140 *	3232602	44	68
	CTV 160 *	3232603	44	73
	CTV 180 *	3232604	44	78
	CTV 200 *	3232643	44	82
	CTV 220 *	3232644	44	88
	CTV 240 *	3232645	44	98

\* Indicare il modello del rullo al momento dell'ordine

\* When ordering, the roller model must be indicated

\* Bei der Bestellung muss das Rollmodell angegeben werden

\* Indique el modelo del rodillo al realizar el pedido.

\* Indiquez le modèle du rouleau lors de la commande